

Tailplane
1/16" sheet balsa

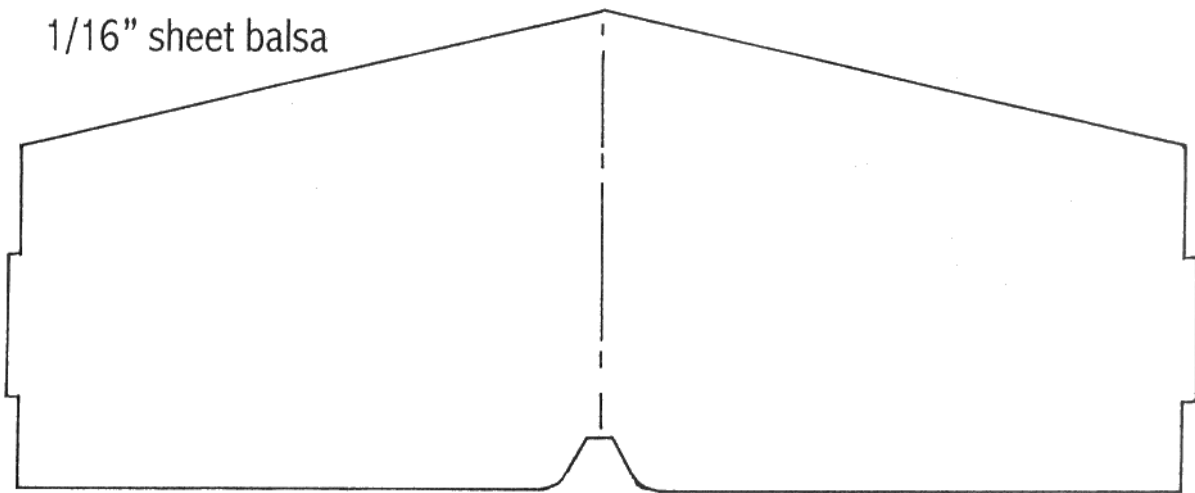

LINNET

bend line

18swg spring wire.

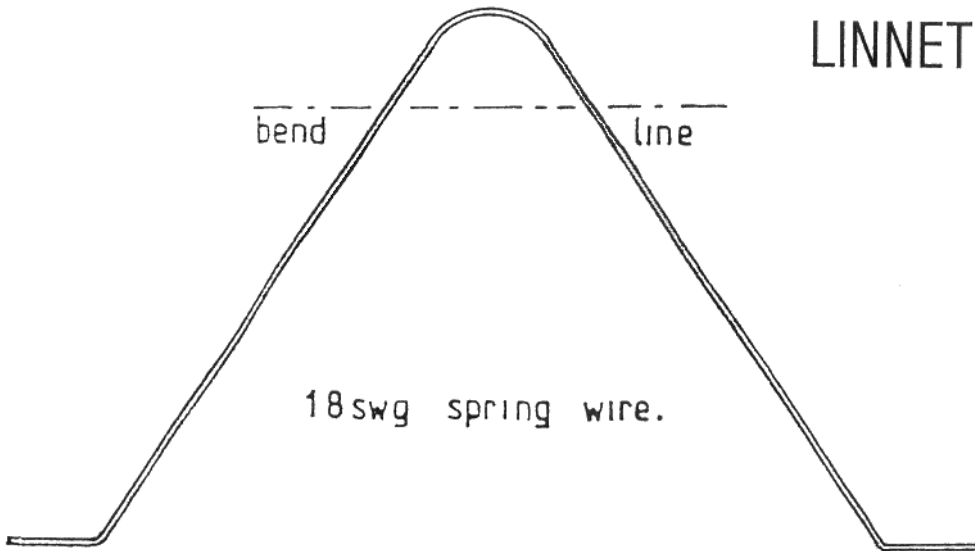

WING.

This is built over the plan, so it is advisable to pin a sheet of grease-proof or tracing paper over it to prevent the cement sticking to it.

Pin down the leading and trailing edges over the drawing, then remove the ribs W1—W4 from the printed sheet (W3 is on the fuselage panel) and cement these into place, together with the tip pieces. Then cement the spar in place and you should have two wing-halves as shown in fig. 3. When both sides are set, lift them from the plan, and assemble them with the tips raised as in fig. 4. Build up the centre section with short pieces of the same materials as the wing, and well cement round the spar joint. See fig. 5. Then cover the centre-section with note paper, or use a double layer of tissue when covering.

When it is quite set, remove the wing from the plan, and shape the trailing edge as shown in fig. 3, but leave the centre part square to fit the fuselage. Round off the leading edge and tips, smooth down the whole wing and apply a coat of dope before covering.

COVERING.

The fuselage and wing require covering with the tissue paper supplied. Start with the fuselage and cover each side separately. Cut

strips of tissue wide enough to allow paste for sticking it to the framework fuselage, stretch a strip of the tissue on other sides, leaving a gap on the bottom pin.

When the paste is dry, lightly sand it, and when it is thoroughly dry again also help to tighten the paper. Apply tailplane and fin.

Cover the wing with 4 pieces, centre-section. Start with the bottom the outer edges only. There is no nose. When covering the top surface start lap the outer pieces onto it and remove end to end, to help preserve the airfoil.

Dope each half-wing separately, when it is half-dry, to prevent it warping.

FIG. 3

BUILD WING IN TWO SECTIONS OVER PLAN.

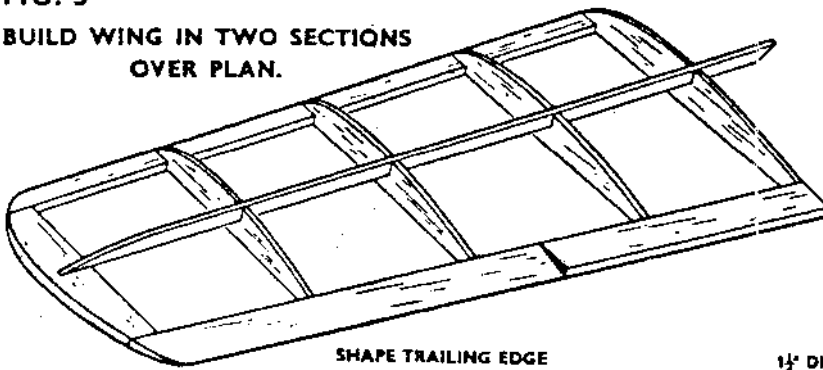
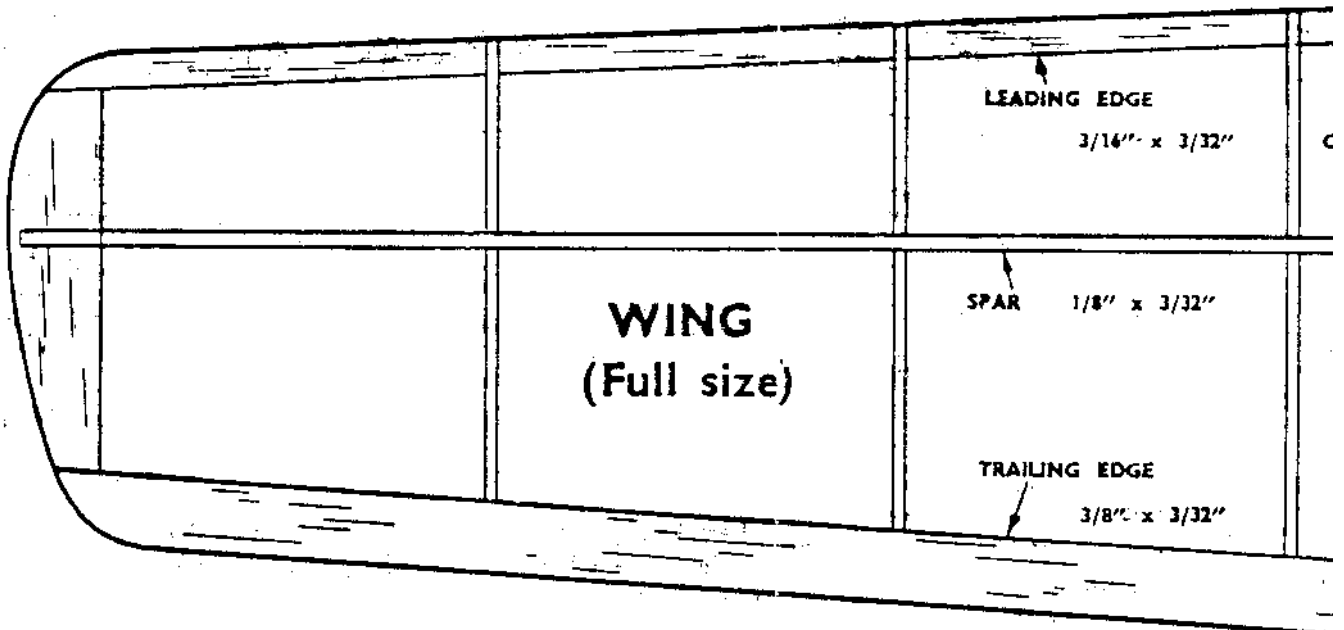

FIG. 4

RAISE WING-TIPS AS OBTAIN DIHEDRAL ASSEMBLING THE TWO



"LINNET"

enough to allow a small overlap. Use dope on the framework. Apply some to one side of the tissue over it and smooth out any wrinkles. Repeat this for the flap on the bottom surface below the rear motor

dry, lightly spray the tissue with water to shrink it. When thoroughly dry again, apply a coat of dope. This will seal the paper. Apply a thin coat of clear lacquer to the

with 4 pieces, and use a separate strip for the bottom surface and apply the paste to it. There is no need to stick the paper to each rib. On the bottom surface start with the centre-section, then overlap the paper to it and remember to keep the paper taut from the spar to preserve the airfoil shape.

Apply the paper separately, and pin it down to a flat board to prevent it warping.

DECORATING.

The appearance of the finished model can be improved by the addition of a little cellulose paint. This should be applied to the fuselage, to save weight, unless it is sprayed on. Paint by hand, applying it quickly and evenly with a brush. Do not put it on heavily or the model will not fly well.

The transfers can be affixed to the wing or fuselage if lettering or decoration is required.

MOTOR.

This is composed of two 9in. elastic bands with a hook at one end. Lubricate them with Frog Rubber Lubricant or Castor Oil. Hook them into the fuselage with the help of a length of wire. Insert it into the fuselage. (If a thread is being used, tie a weight to it through).

Hook the bands on to it through the opening at the rear motor pin (cane) through the holes in the fuselage.

ING-TIPS AS SHOWN, TO
JOIN DIHEDRAL WHEN
JOINING THE TWO HALVES.

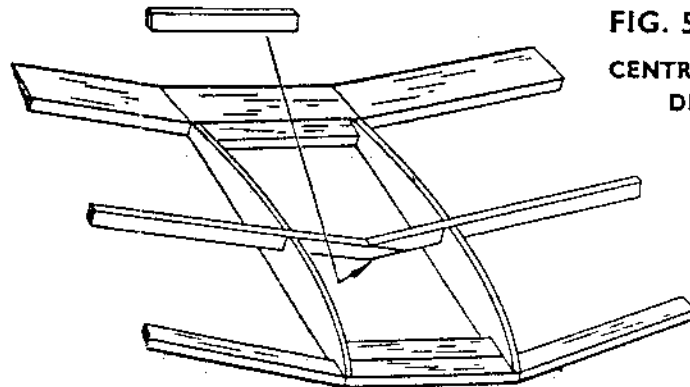
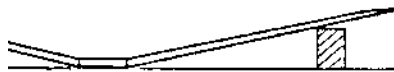
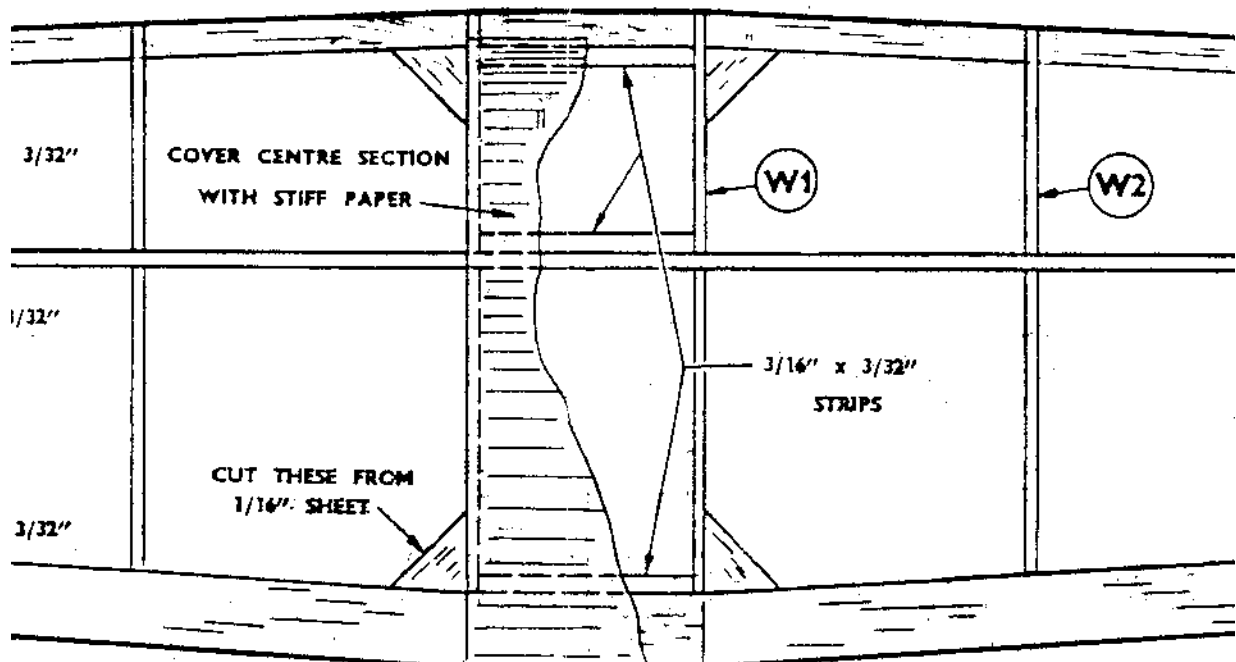

FIG. 5
CENTRE-SECTION
DETAIL



Cat. No. 627 FK

can be improved considerably. This should be restricted to sprayed on lightly. It can be evenly with a soft brush. Do fly well.

wing or fin, and any other

ic bands which are supplied. or Castor Oil, and insert them th of wire or thread. Bend a it into the front end of the weight to one end and drop

opening at the rear and insert les in the fuselage and through

5

RE-SECTION
DETAIL.

the loops of elastic. Pull the bands out through the front, and hook them on to the airscrew shaft (complete with Airscrew).

Fit the wing in place through the opening in the fuselage. It is held in place with two elastic bands, stretched over the centre-section, and hooked over the pins pushed into bulkheads 2 and 3.

The model is now complete and ready for flying. A drop of thin oil on the airscrew shaft will improve the running.

FLYING.

This model is intended to be flown out of doors, but choose a calm day for your first test.

Test-glide the model first to check the balance. Hand-launch it in a slight downward direction. If it dives to the ground, carefully bend up the rear edges of the tailplane, known as elevators, or glue a small weight in the rear end of the fuselage. If the model climbs steeply and stalls, bend the elevators down slightly, and/or add a small weight to the nose of the fuselage. A small nail or drawing pin can be pushed into the cowl block for this.

When the glide seems satisfactory, put a few turns on the motor and launch the model (into wind) if any. The turn can be adjusted by bending the fins, or by twisting the wing slightly.

Increase the turns on the motor gradually, up to a maximum of approximately 350; if the motor is not lubricated, the turns must be limited to 200. An unlubricated motor will wear and break very quickly. Stretching the elastic while winding will enable more turns to be obtained.

This model will take-off from the ground without assistance. Having wound the motor, place the model on a smooth surface, and release it directly into wind.

Designed and Made in England by
INTERNATIONAL MODEL AIRCRAFT LTD.
MORDEN ROAD, MERTON, LONDON, S.W.19.

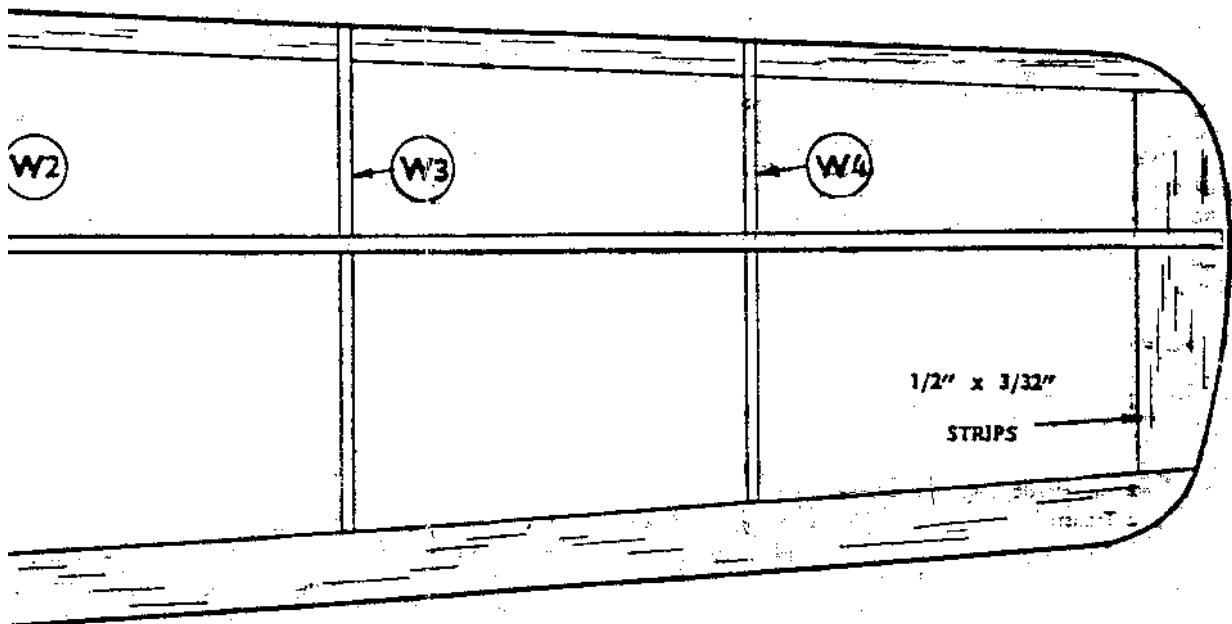

Senior Series

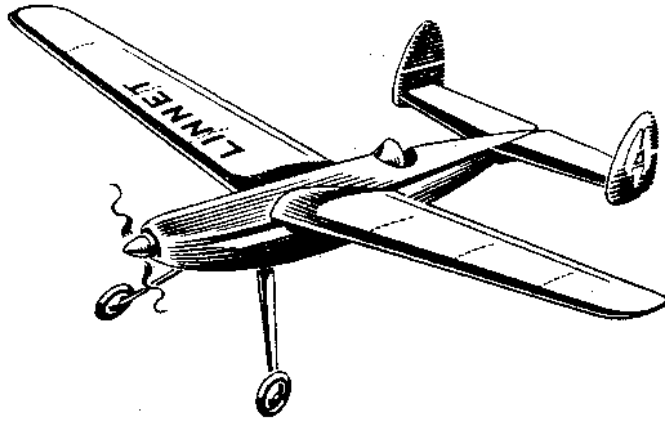

VIEW OF FINISHED MODEL.

INTRODUCTION.

This model is one of the Frog Senior-Series, which consists of a range of models of near-scale design and appearance, representing popular full-size sports 'planes, all approximately 18in. span.

They embody very simple and quick constructional methods, as in the Frog Junior Series models, all the main parts being ready-cut to shape, and only require cementing together.

To ensure a satisfactory job, study the plan and check the parts with it before commencing. Assemble the model step by step as shown.

Cement and dope are not included in this kit, but they can be bought at any model shop. Use quick-drying balsa cement such as Frog Universal. You will also need a balsa-cutting knife or a razor blade, and a few pins.

When you have built this model, remember there are others in this series equally attractive.

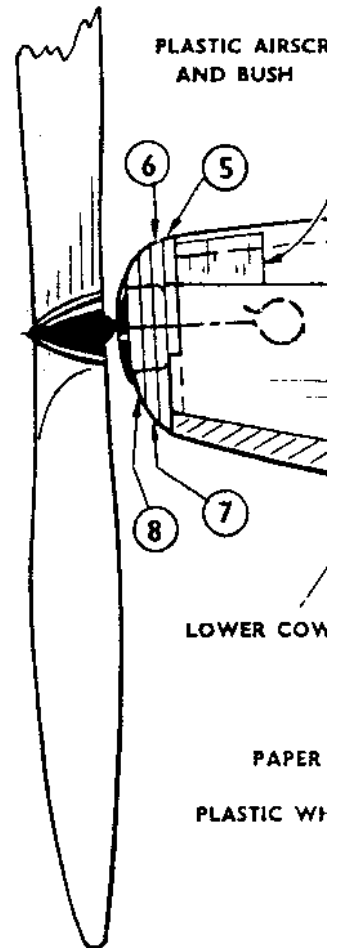

THIS KIT CONTAINS:

- 1 Plan and Instructions.
 - 1 Balsa Sheet of cut-out fuselage sides.
 - 1 Balsa Sheet of cut-out tailplane and fin.
 - 1 Balsa Sheet of cut-out bulkheads, ribs, etc.
 - 1 Balsa Sheet of cut strips.
 - 1 Balsa Block for front lower cowl.
 - 1 Shaped wire undercarriage.
 - 1 Propeller with shaft and bush.
 - 1 Piece cellastoid for windscreen.
 - 1 Piece cane for motor pin.
 - 2 Wheels.
 - 2 2in. elastic bands for wing.
 - 2 9in. elastic bands for motor.
 - 2 Transfers.
 - 1 Piece tissue for covering.
 - 1 Piece sandpaper.
- } in envelope.

BUILD

FUSELAGE ASSEMBLY.

Carefully remove all the excess balsa with a sharp knife or a piece of razor blade by cementing pieces of balsa to the fuselage sides. Then cement bulkheads 2 and 3 as shown in fig. 1. Make sure they are in place. When the fuselage is assembled and the front pieces 5, 6, 7:

UNDERCARRIAGE.

Bend the top part of the fuselage sides as shown in the side view drawing; then cement the undercarriage to the fuselage.

"LINNET"

SIDE VIEW (Full size)

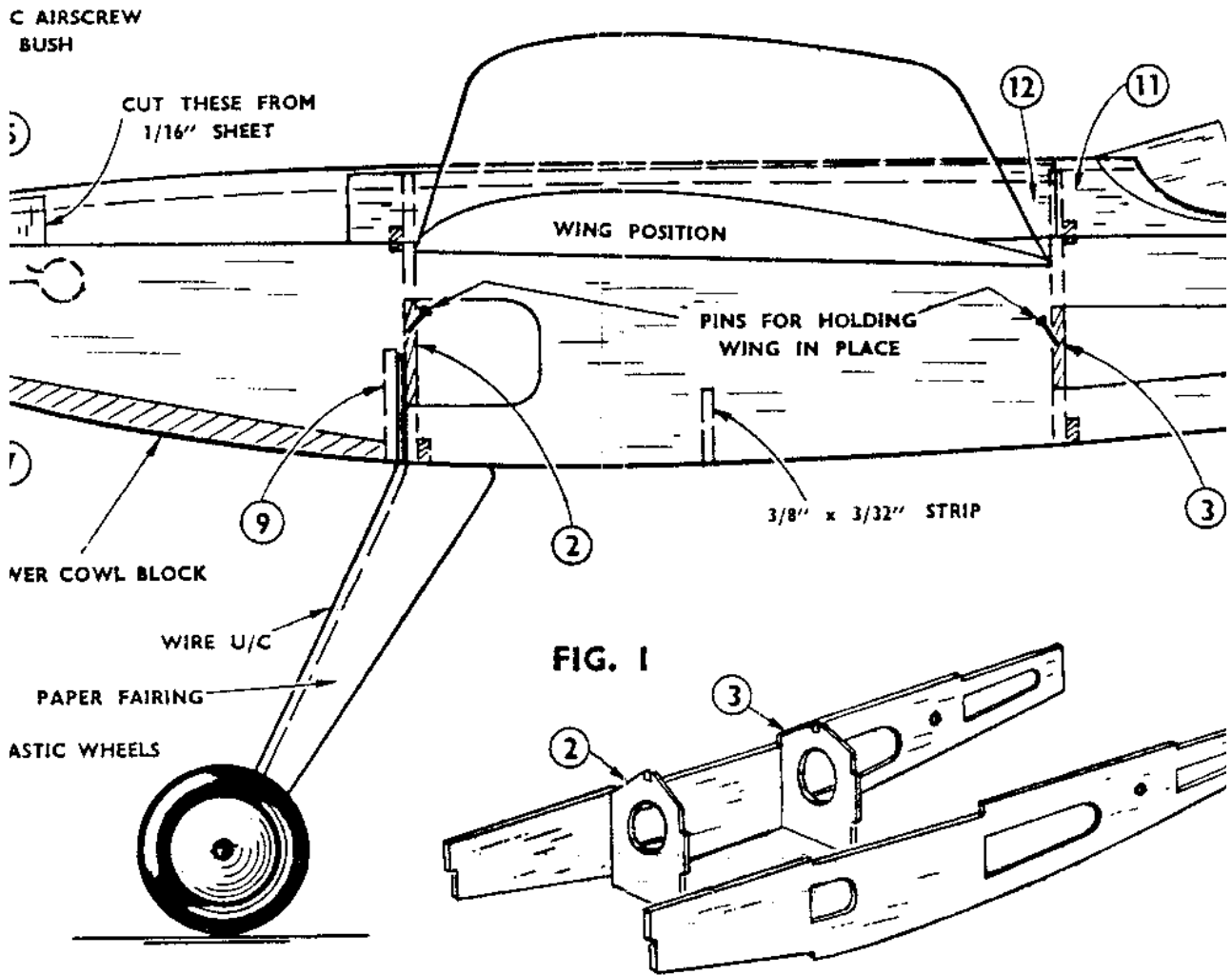

FIG. 1

BUILDING INSTRUCTIONS.

A. PREPARE THE PARTS.

Prepare all the parts from the balsa sheet using a balsa razor blade to separate them with a clean edge. Start with the balsa strip cut from scrap, to bulkheads 2, 3 and 4. Cement the bulkheads 2 and 3 to one of the side panels 1, as shown in the drawing. They are upright, and allow to dry. Then cement the bulkheads 2 and 3 to the other side panel 1. When these are set, assemble the other bulkhead 4, and cement it to the side panels 1, 2, 3 and 5, 6, 7 and 8.

B.

Prepare the shaped wire piece forward as shown in the drawing; then cement it into place in front of bulkhead 2.

Prepare the wire U/C with the piece 9 against the wire to hold it in place. Cement the rear cowl block, 3/16in. thick, between part 9 and the fuselage. Shape it after it has set.

Fit the wheels in place and bend over the ends of the axle with small paper washers to the axles to hold them on. Prepare the paper fairing from paper to the shape given, fold them, and glue them to the fuselage.

Cement the half-bulkhead 10 to a cross-strut to fit between the sides.

Fit the top front stringer and cockpit pieces 1 and 2. Then cut the small pieces of 1/16in. sheet from scrap as shown. The rear stringer is fitted after the tailplane is in place.

Cement the wing mounts 12 in position as shown in the drawing.

18" SPAN RUBBER-POWERED

Cat. No.
627 FK

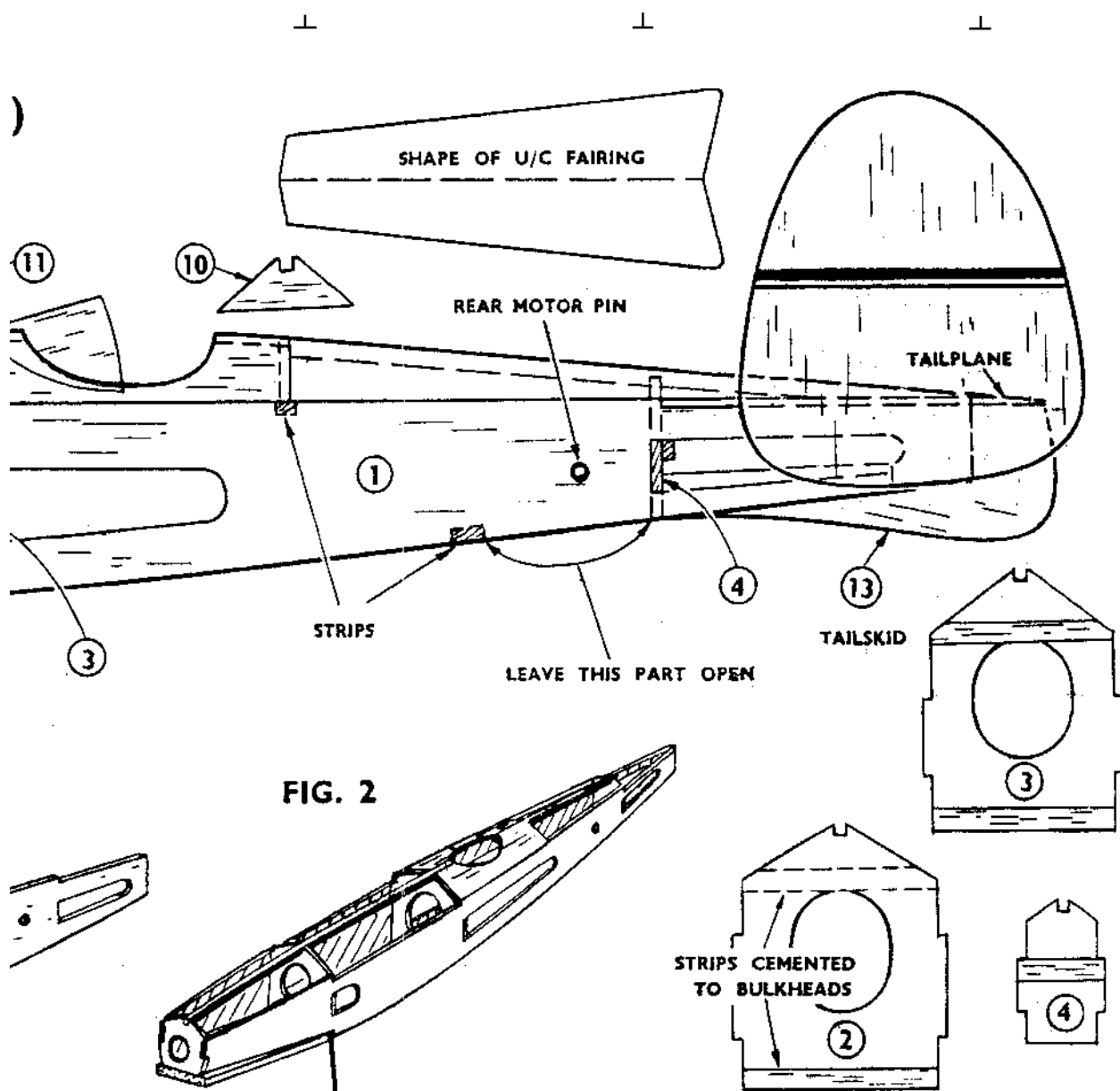

FIG. 2

in place. Then fix the lower
t 9 and the nose piece, and

the ends of the wire, or glue
them on. Cut the two fairings
and glue them to the wire legs.
Dress-strut which should be cut

pieces 11 in place, see fig. 2.
from scrap to fit to the nose as
tailplane is assembled.

as shown.

TAILPLANE AND FIN.

Remove the shaped tailplane from the balsa panel, round off the edges and sandpaper the surface smooth. Then cement it to the fuselage as shown in the side view. Cement the fins on the ends of the tailplane together with the small oblong pieces. Then fit the rear stringer in place.

Fix the shaped windscreen with cement, holding it in position until it has set.

Cement the tailskid 13 in place as shown.

Remove any sharp corners with sandpaper, and smooth down the whole model to obtain a good finish. Apply a coat of dope or clear lacquer before covering.

+

+

+

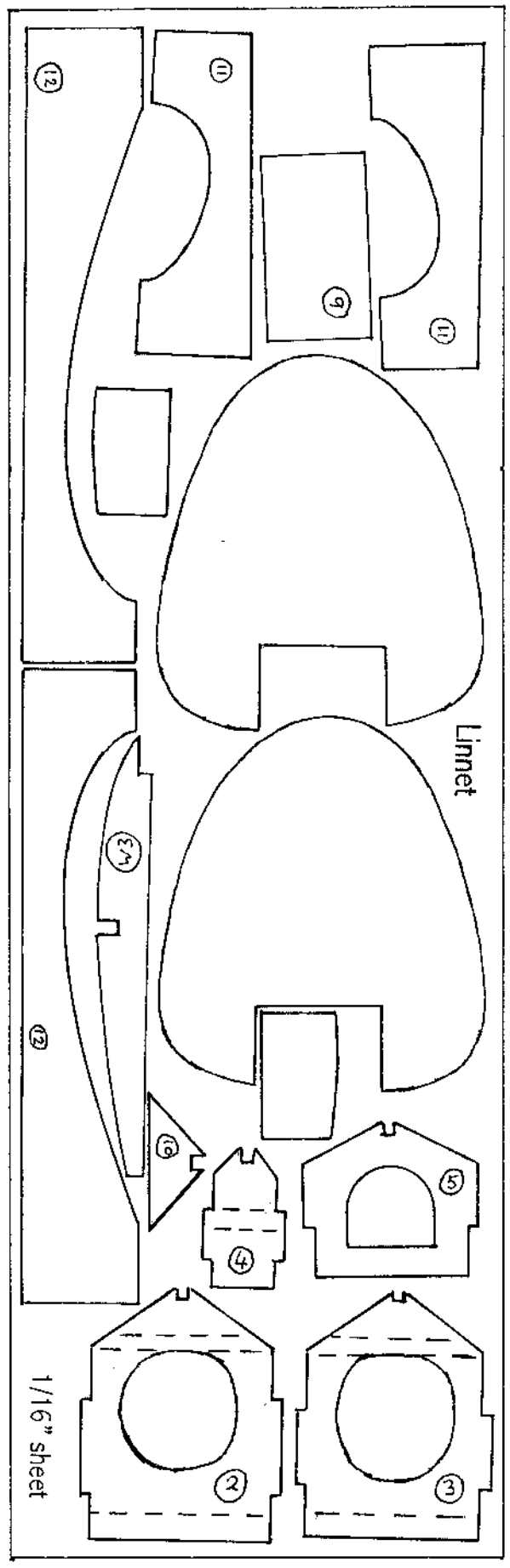

+

+

+

+

+

+

+

+

+

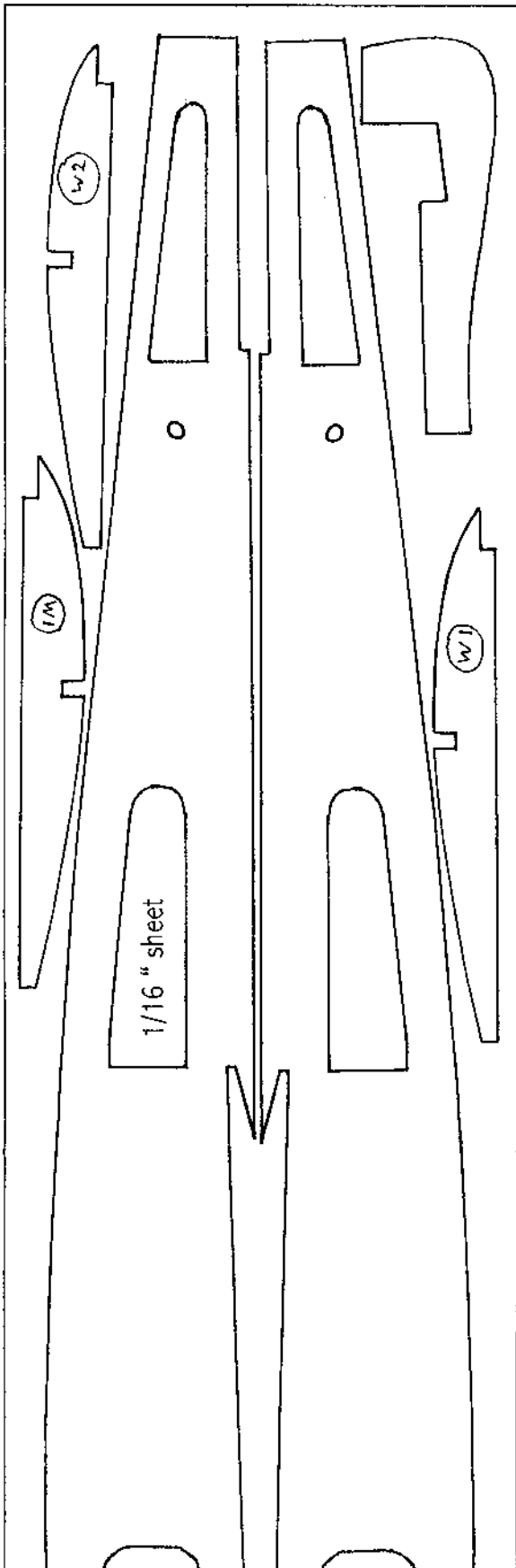

T

T

T

T

